



 PARTITION SYSTEMS

 Proudly Canadian for over 50 years

EXECUTIVE
DEMOUNTABLE WALLS

EXECUTIVE



Partition Systems has been helping businesses adapt to their changing organizational needs since 1970. Executive demountable walls allows your workplace to be reimaged to feature private offices, collaborative spaces, spacious meeting rooms, and more. Boasting the best sound resistance in the industry, with Executive walls, privacy is always maintained. Featuring easy-to-install, snap-on panels and a wide selection of custom options including mountable furniture and accessories, you'll be able to ensure an elegant and efficient environment that evolves along with you.



EXECUTIVE



Executive demountable walls are pre-engineered and 100% factory fabricated, allowing for a simple and clean installation. Units can stand freely or be integrated with the existing architecture for a seamless look.

Features

- ↔ 4 ¼" wall thickness including solid snap-on or glass panels
- 🔧 Single trade install
- ↔ Fully reconfigurable unitized and continuous butt-jointed design
- 📦 Accepts mountable furniture and accessories from most manufacturers
- 🔊 Solid wall sections deliver a sound transmission class (STC) of 46 to 51. Double pane glass with 3" air space, 5 mm and 6 mm unitized, delivers an STC of 43
- 🔌 Can be pre-wired with electrical kits (relocatable) or roughed in electrical
- 📏 6 mm, 10 mm, and 12 mm unitized single pane glass and 10 mm and 12 mm butt-jointed glass
- 🚪 Compatible with all Partition Systems doors
- 🍁 Canadian made and manufactured in Alberta
- 🌿 Can contribute to LEED credits
- ♻️ Made from 100% reusable material
- ☀️ 10 year warranty



Full and partial height Executive demountable walls integrate seamlessly with drywall-based construction. Once base building is completed demountable walls can be installed on top of finished flooring and attached to T-bar or bulkheads.

Limitless Customization

Choose between solid wall panels, glass sections, or mix and match to suit your needs. Clear anodized frames come standard, or choose powder coated frames from a selection of custom colours.

Solid wall panels are available in an array of finishes including:

- Low or high pressure laminate
- Wood veneer
- Painted MDF
- Steel faced panels
- Fabric tack board
- Back-painted glass white board

You can even add digital screens or apply large format photos to create murals or showcase your brand.

With Executive walls, every solid surface is compatible with mountable furniture and accessories available from most office supply distributors. Utilizing the natural reveal between face panels, hooks, trays, and shelves can be added for a clean look that can be changed or updated without damage to the wall.

► [View swatch samples and learn more about available options](#)



Doors to Match

Custom door options are also available in a variety of styles, including hinged, pivot swing, and sliding barn doors. Doors are available with aluminum framing or in solid core wood and can be finished to complement the surrounding walls in paint, laminate, or wood veneer. See page 13 for examples of door options.



*Featured: Executive demountable solid walls
with Corporate demountable glass front*

Fits Your Technical Needs

All solid wall sections can come pre-wired and are compatible with power outlets, phone and data outlets, light switches, and thermostats. These electrical options can be added during the initial installation or later on to accommodate your evolving office needs.

Electrical kit options:

- Standard duplex power outlet kit includes a duplex outlet, an electrical box, and BX cable.
- Quad power outlet kit includes two duplex power outlets, electrical boxes, and BX cable.
- Voice, data, switch, and AV kit includes an electrical box and EMT conduit. Jacks and cabling are not included.

Note: Electrical kits don't include connection to the building electrical system.





Create the appearance uninterrupted glazing with continuous butt-jointed glass.
This method can be combined with Executive solid demountable walls and can even be used around corners.



Featured: Executive demountable over 12' high



Environmentally Conscious

All aspects of the Executive walls are 100% reusable and are constructed from repurposed and recyclable materials. What's more, our glazing options allow for more natural light to reach the interior of your office space. These features contribute to LEED credits for your building, ensuring energy efficiency, reduced resource costs, and a bright, clean workspace for employees.

► **Learn more about how Partition Systems is environmentally conscious**

Acoustically Secure

Executive demountable walls boast the highest sound rating in the industry, at a standard STC of 46 to 51 on solid walls. With a sound transmission class at or above traditional drywall, you can ensure distraction-free workspaces where privacy is always maintained.





Executive demountable walls with unitized double glass fronts provide high performance STC, ensuring acoustic privacy while maintaining an open design flow between offices and common areas.

EXECUTIVE EXAMPLES

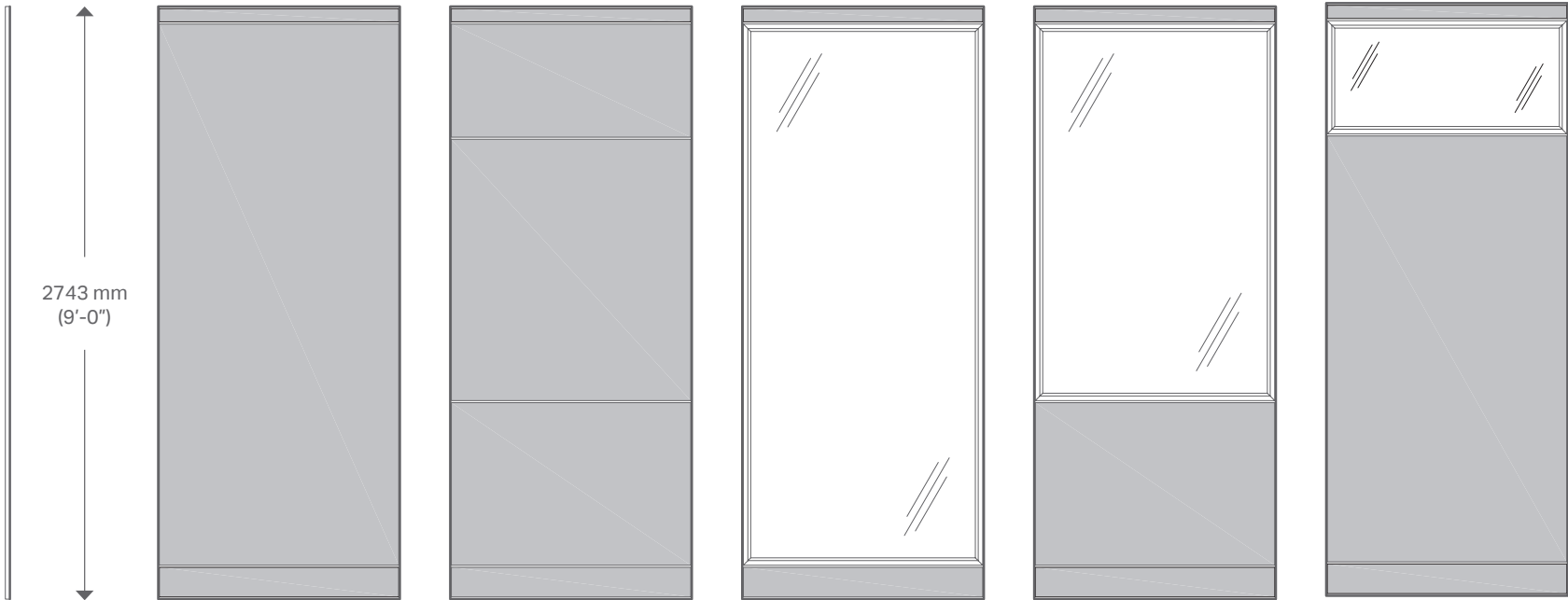

XTCA-WS
Wall start or end
cap condition

XS1
Monolithic solid panel

XS3
Stacked solid panel

XG1
Monolithic glass panel
Available in:
Single 6 mm
Single 10 mm
Double 6 mm

XS1G1: HALF
Half glass panel
Available in:
Single 6 mm
Single 10 mm
Double 6 mm

XS1G1: CLERESTORY
Clerestory glass panel
Available in:
Single 6 mm
Single 10 mm
Double 6 mm

EXECUTIVE EXAMPLE WITH MONOLITHIC GLASS FRONT AND SLIDING DOOR

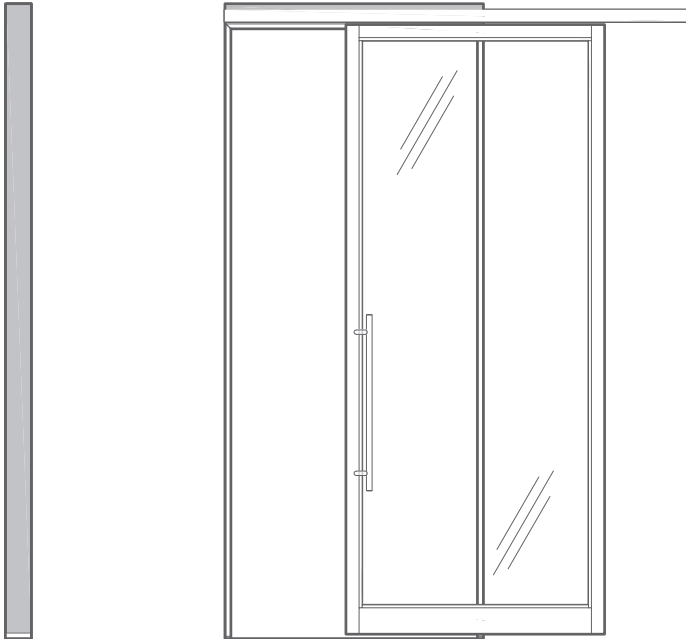

**X90C/X2WP/
X3WP/4WP**
Corner or
intersection

XDFB
Sliding door frame with
aluminum framed door

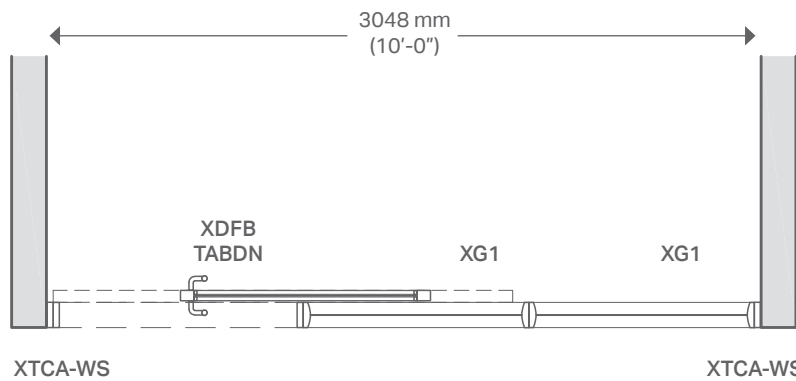

EXECUTIVE EXAMPLE WITH MONOLITHIC GLASS FRONT AND HINGED DOOR

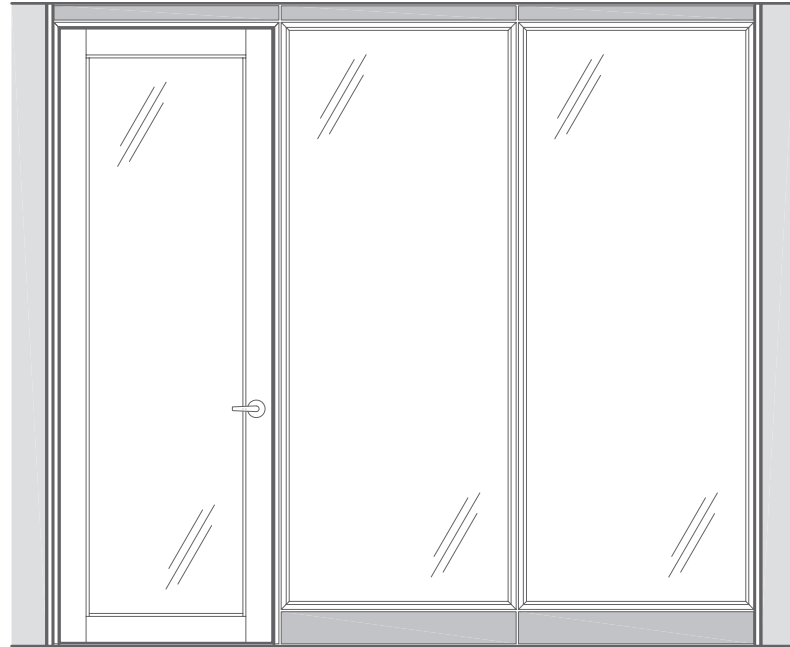
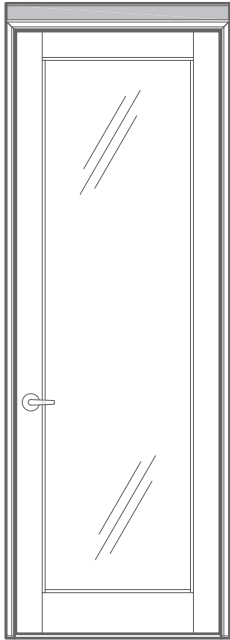
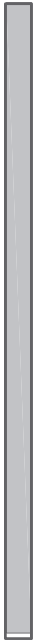

**X90C/X2WP/
X3WP/4WP**
Corner or
intersection

XDFH or XDFP
Hinged or pivot swing
door frame with aluminum
framed door

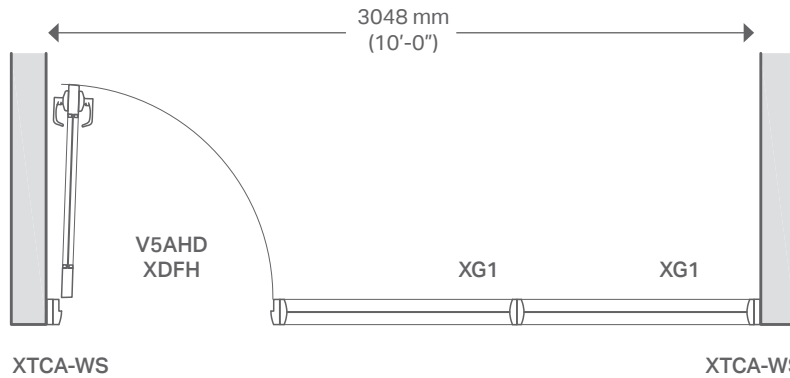

EXECUTIVE DOOR EXAMPLES

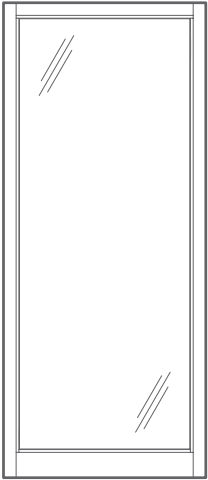

Aluminum narrow framed glass door

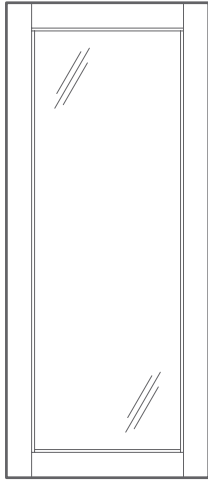

Aluminum wide framed glass door

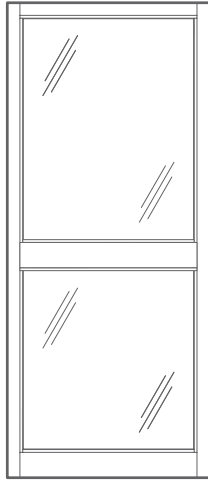

Aluminum narrow framed split lite door

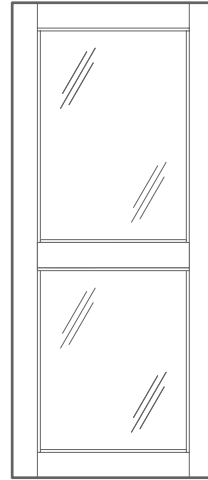

Aluminum wide framed split lite door



Frameless glass door (sliding door only)

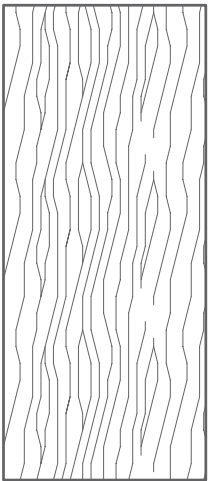

Solid wood door

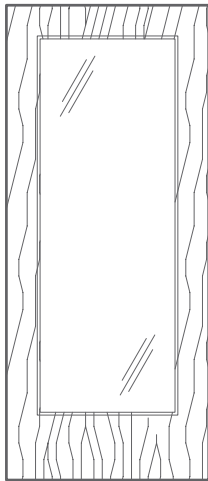

Wood door with full lite

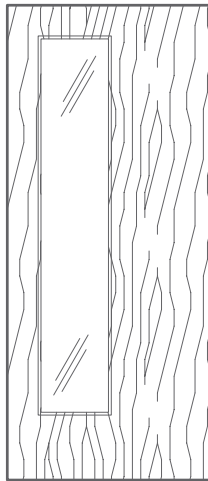

Wood door with half lite

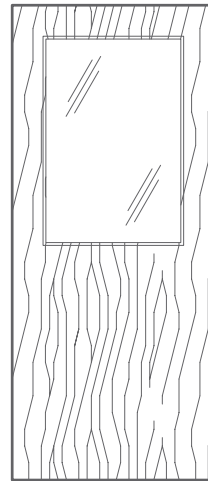

Wood door with partition lite

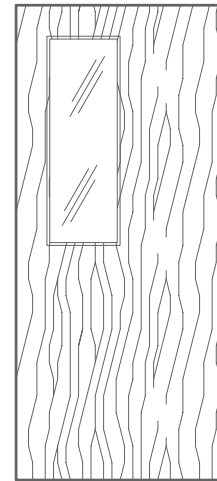

Wood door with half partition lite



 PARTITION SYSTEMS
partitions.com

For more information, contact your local dealer
or Partition Systems at 1-800-567-2454