



 PARTITION SYSTEMS

 Proudly Canadian for over 50 years

CORPORATE  
DEMOUNTABLE WALLS

# CORPORATE



As your business grows and changes, your workspace needs to evolve along with it. Partition Systems has been helping businesses adapt to their changing organizational needs since 1970. Corporate demountable walls offer an affordable and dependable solution that allows you to update your office with easy-to-install, stylish wall panels that can reinvent any space.



# CORPORATE



Corporate demountable walls are 100% factory fabricated and shipped ready-to-install, reducing downtime, cost, and mess. Units can stand freely or be integrated with the existing architecture for a seamless look.

## Features

- ↔ 2 ¼" wall thickness including solid vinyl, laminate, fabric, or glass panels
- 🔧 Single trade install
- ✂️ Fully reconfigurable unitized and continuous butt-jointed design
- 📱 Accepts mountable furniture and accessories from most manufacturers
- 🔌 Electrical and data can be pre-wired or roughed in
- 📏 6 mm and 10 mm unitized single pane glass and 10 mm butt-jointed glass
- 🚪 Compatible with all Partition Systems doors
- 🍁 Canadian made and manufactured in Alberta
- 🌿 Can contribute to LEED credits
- ♻️ Made from 100% reusable material
- ☀️ 10 year warranty



Corporate unitized demountable glass walls can be paired with Corporate or Executive solid walls, or installed within a finished drywall opening with a Vision V5 aluminum framed glass door as shown here.



### **Flexible Options**

Choose between a variety of colours and custom finishes that fit the look of your organization. Clear anodized frames come standard, or choose powder coated frames from a selection of custom colours.

Each section of wall can be built from a unique combination of solid wall panels and glass, customizable to the millimetre, meaning that panels can be fit into any space with ease.

Corporate walls are compatible with shelving and furniture systems from most retailers, and can be secured using vertical slotted standards.

## Doors to Match

Custom door options are also available in a variety of styles, including hinged, pivot swing, and sliding barn doors. Doors are available with aluminum framing or in solid core wood and can be finished to complement the surrounding walls in paint, laminate, or wood veneer. See page 13 for examples of door options.



*Featured: Corporate 10 mm butt-jointed glass wall with sliding barn door*

### **Environmentally Conscious**

All aspects of Corporate walls are 100% reusable, leading to a reduced environmental impact and lower costs. By eliminating messy drywall installations, the reduction in dust and paint fumes lead to a marked improvement in air quality. Corporate walls contribute to LEED credits for your building through its use of recycled content and regionally sourced materials.

► [Learn more about how Partition Systems is environmentally conscious](#)

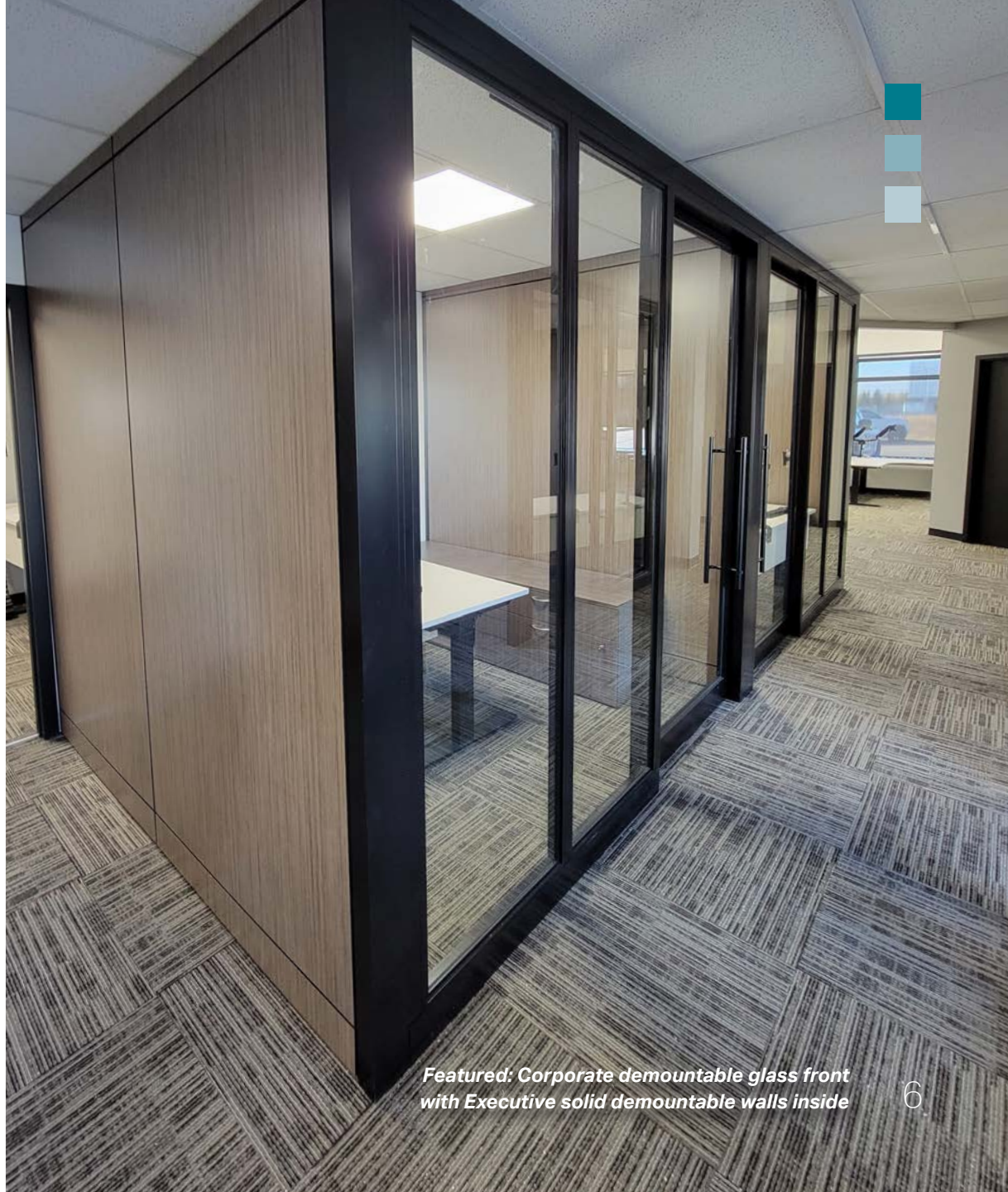

*Featured: Corporate demountable glass front with Executive solid demountable walls inside*



### **Fits Your Technical Needs**

All solid wall sections can be pre-wired to meet your electrical and data needs. Our CSA-certified wiring system, coupled with our removable paneling means that you can expect easier electrical installations with a lower cost than traditional wiring systems. All wall sections can be fitted with power outlets, phone and data ports, light switches, and thermostats, as required.

Electrical wall section options:

- Standard duplex power outlet kit includes a duplex outlet, an electrical box, and BX cable.
- Quad power outlet kit include two duplex power outlets, electrical boxes, and BX cable.
- Voice, data, switch, and AV kit includes an electrical box and EMT conduit. Jacks and cabling are not included.

Note: Electrical wall sections don't include connection to the building electrical system.



## Grows With You

As your organization grows and changes, Corporate panels can be moved, removed and repurposed without the hassle of a full and expensive renovation. Create private offices, shared workspaces, and spacious meeting rooms, or remove these spaces as your needs and priorities change. You may not know what your organizational needs will be in five years, but with Corporate walls, you'll be ready for any adjustment.



*Featured: Corporate unitized demountable glazing combined with existing drywall*

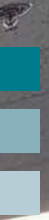

Corporate demountable glass combined with drywall offers a cost effective glass front solution comparable in price to stick-built. Create a flush faced look with matching aluminum end capping to cover unfinished drywall.

CORPORATE EXAMPLES

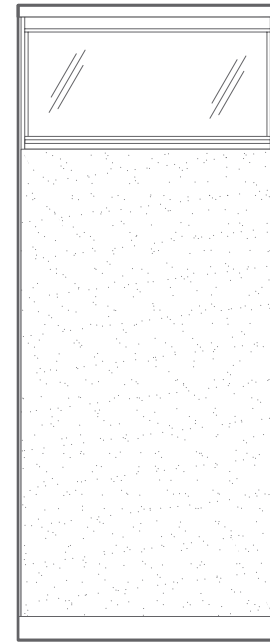
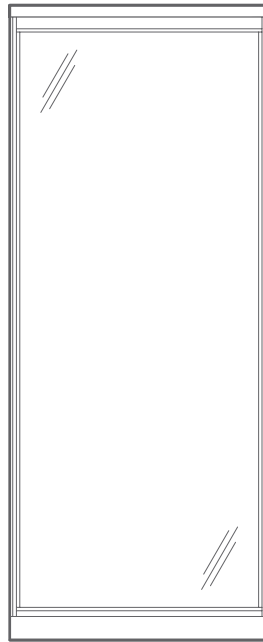
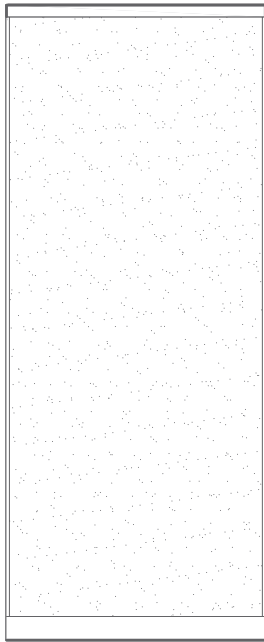
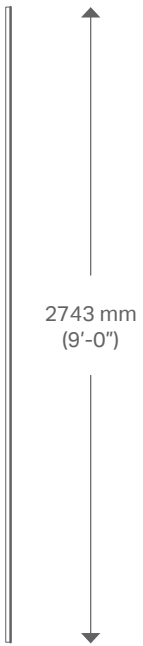

**CTCA-WS**  
Wall start or end  
cap condition

**CS1**  
Monolithic solid panel

**CG1**  
Stacked solid panel  
Available in:  
Single 6 mm  
Single 10 mm

**CS1G1: HALF**  
Half glass panel  
Available in:  
Single 6 mm  
Single 10 mm

**CS1G1: CLERESTORY**  
Clerestory glass panel  
Available in:  
Single 6 mm  
Single 10 mm

CORPORATE EXAMPLE WITH MONOLITHIC GLASS FRONT AND SLIDING DOOR

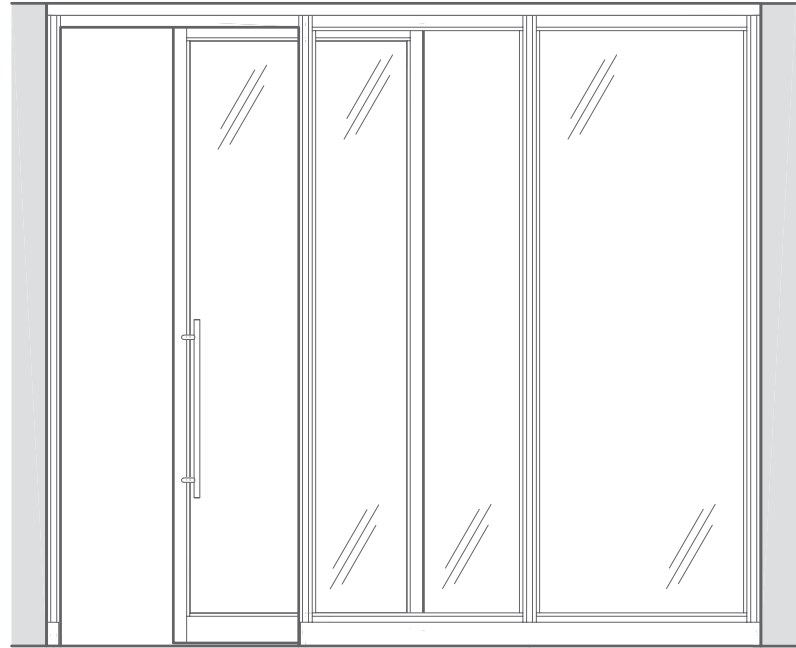

**C90C/C2WP/  
C3WP/C4WP**  
Corner or  
intersection

**CDFB**  
Sliding door frame with  
aluminum framed door

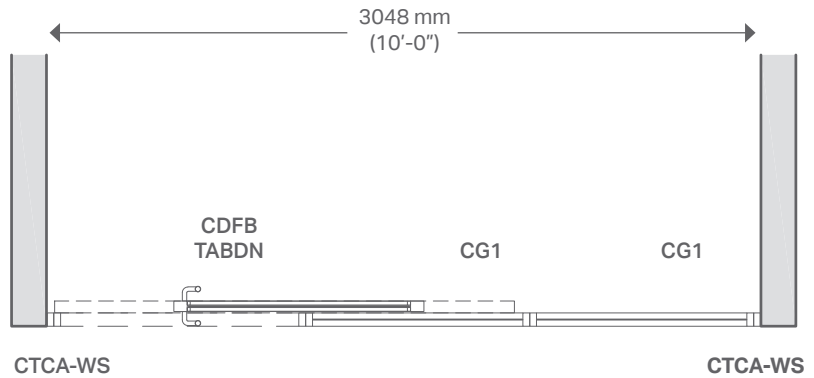

CORPORATE EXAMPLE WITH MONOLITHIC GLASS FRONT AND HINGED DOOR

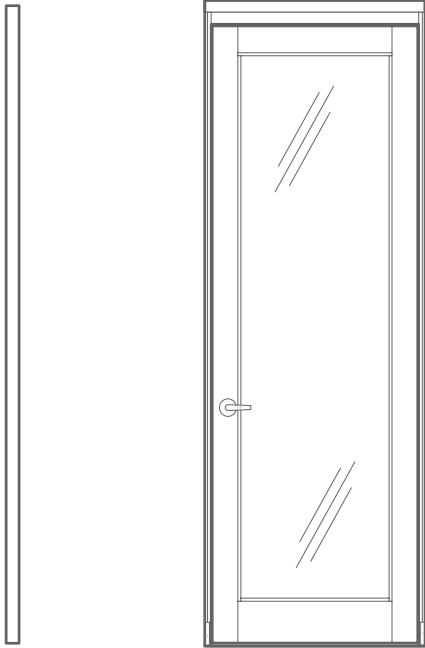

**C90C/C2WP/  
C3WP/C4WP**  
Corner or  
intersection

**CDFH or CDFP**  
Hinged or pivot swing  
door frame with aluminum  
framed door

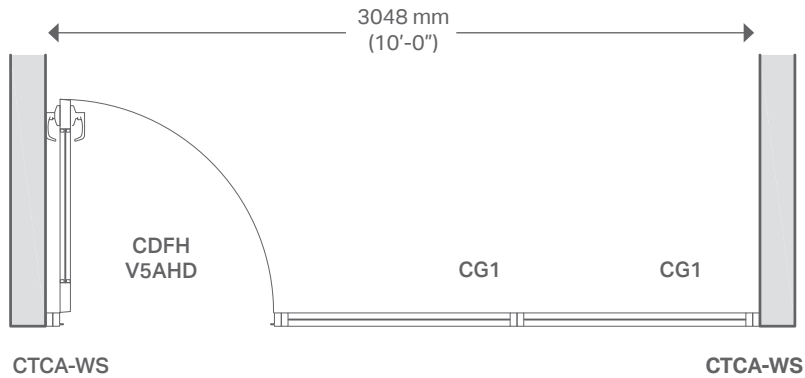
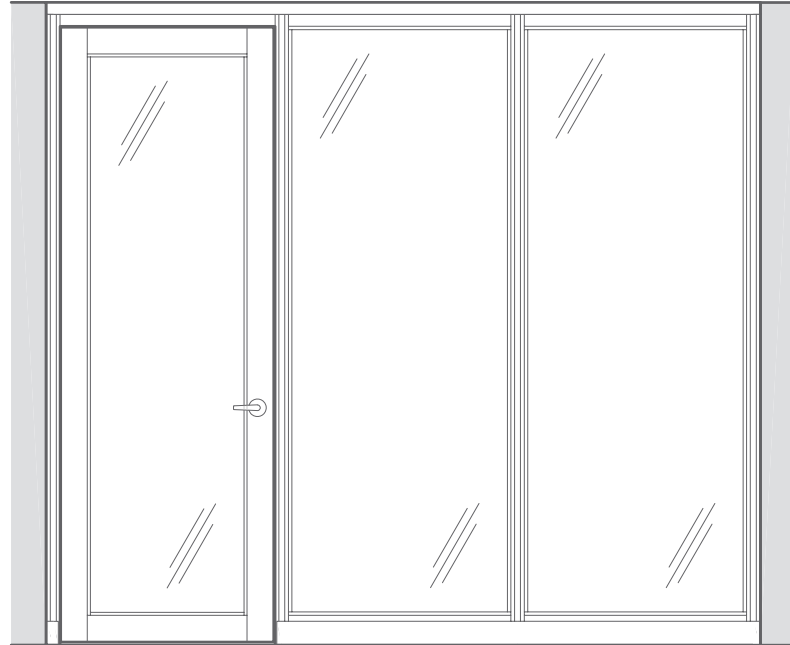

CORPORATE DOOR EXAMPLES

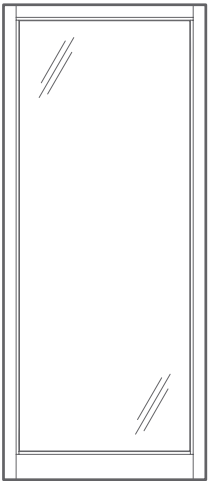

Aluminum narrow framed glass door

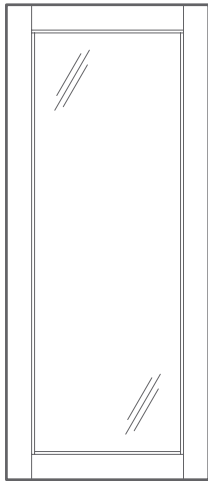

Aluminum wide framed glass door

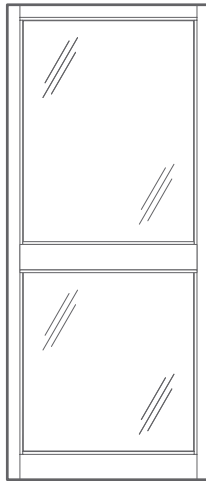

Aluminum narrow framed split lite door

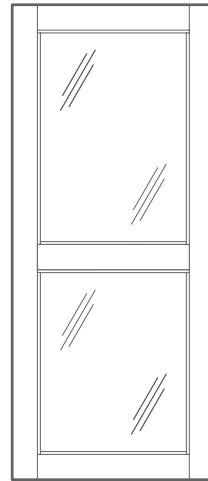

Aluminum wide framed split lite door



Frameless glass door (sliding door only)

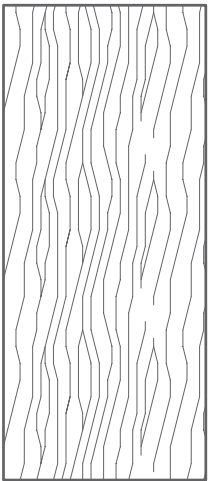

Solid wood door

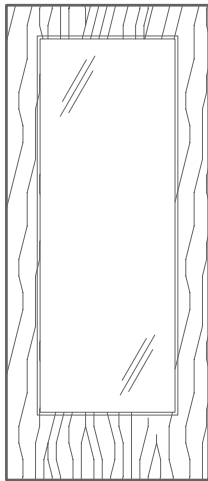

Wood door with full lite



Wood door with half lite

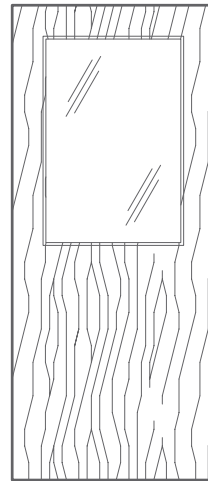

Wood door with partition lite

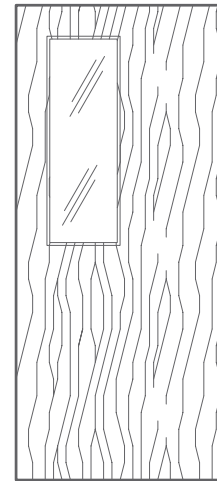

Wood door with half partition lite



 PARTITION SYSTEMS  
partitions.com

For more information, contact your local dealer  
or Partition Systems at 1-800-567-2454